

Goet- Insert Coffee Table ● ● ●

Our Stump Coffee Table is a cross cut slab from a solid timber stump which we combine with a metal insert. The metal insert be plated in copper, brass, bronze, stainless steel or be left a raw steel colour. The insert can also be powder coated in a range of colours.

The timber used to manufacture the coffee table has been reclaimed, recycled or is from an easily sustainable source.

Materials

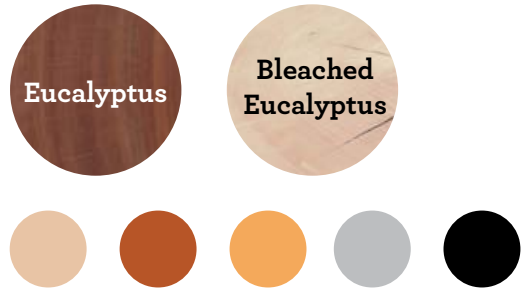

Copper, Brass, Bronze, Stainless Steel
Powder Coating or Raw Mild Steel

Colours

Colours can be determined with client

Technical

+/- 1000mm diameter X 450mm high

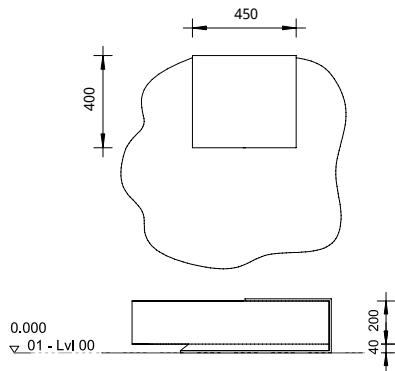

* We can customise the material, colour and size according to your specifications.

Get in touch and we can talk about it.



Turned Stools

Our Turned Stools are handmade on a lathe out of solid timber stumps. The stools can then be finished in various colours or just be left natural.

The timber used to manufacture the coffee table has been reclaimed, recycled or is from an easily sustainable source.

Materials



Colours (we like)



* We can customise the material, colour and size according to your specifications.

Get in touch and we can talk about it.

Shapes



Too Chair ● ● ●

Our Chair is manufactured out of solid kiln dried timber. The seating can be covered in a range of fabrics or leather.

The timber used to manufacture the chair has been reclaimed, recycled or is from an easily sustainable source.

Materials



Ash



Walnut



Pine



Leather



Fabric

Technical

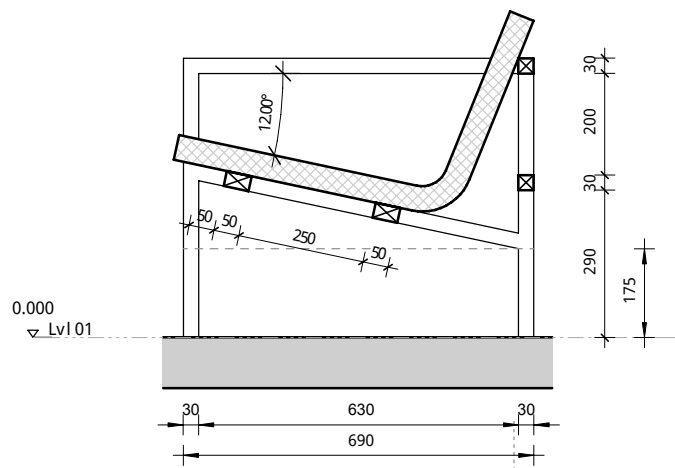

* We can customise the material, colour and size according to your specifications.

Get in touch and we can talk about it.

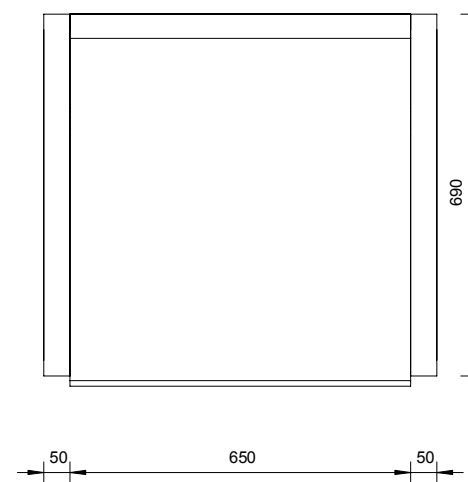
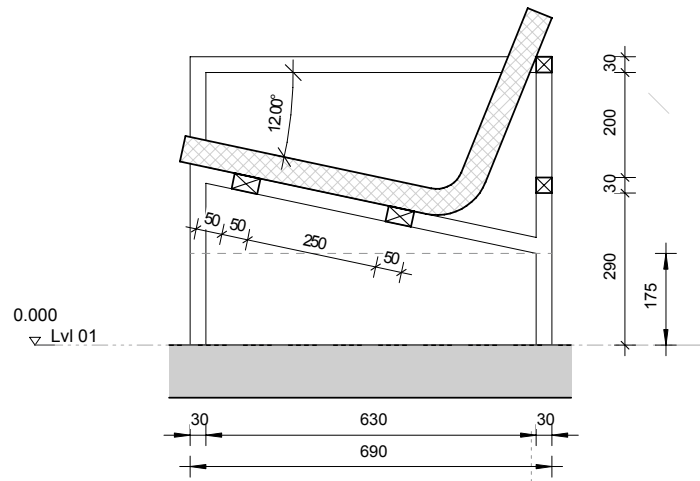
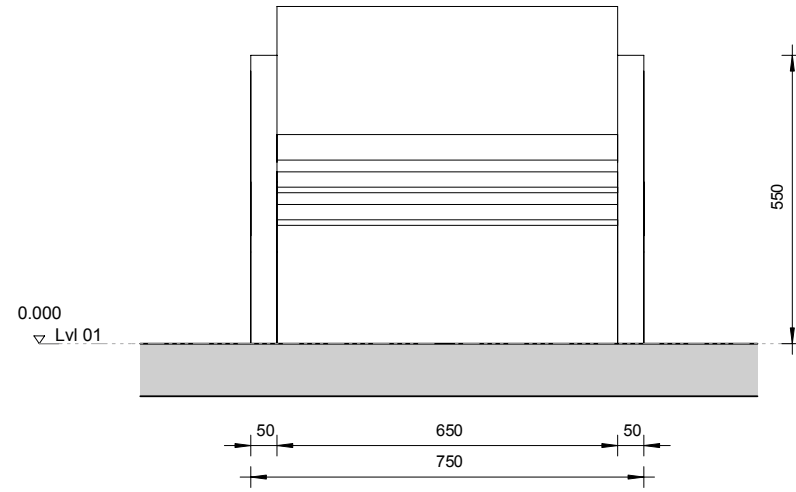
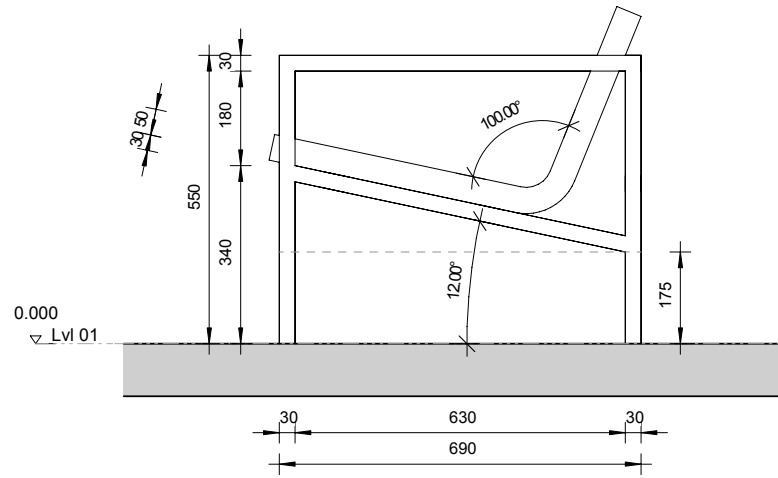

Vessels ●●●

Our Vessels are handmade on a lathe out of solid timber stumps. The vessels can then be finished in various colours or just be left natural.

Materials



Colours (we like)



* We can customise the material, colour and size according to your specifications.

Get in touch and we can talk about it.



Shapes

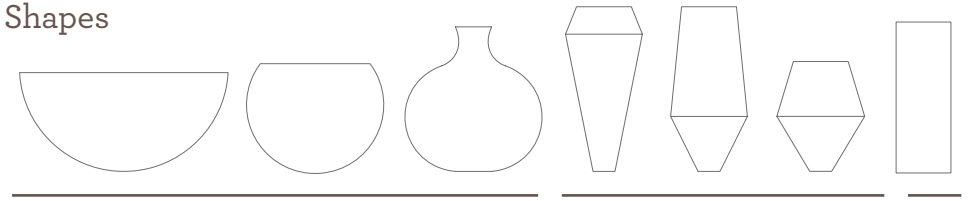

eco

evo

block



Technical

eco

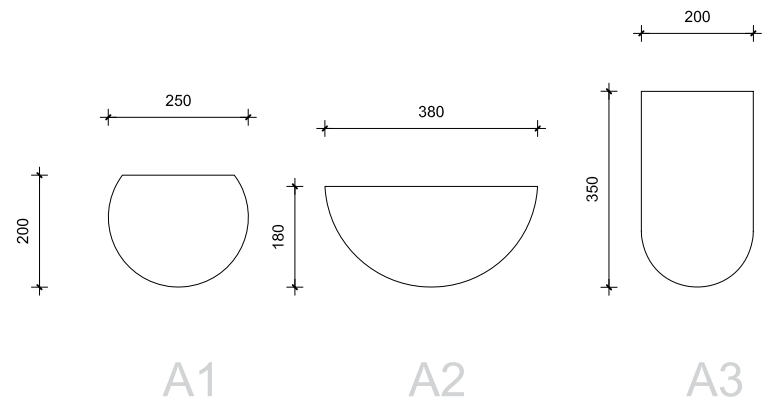

evo

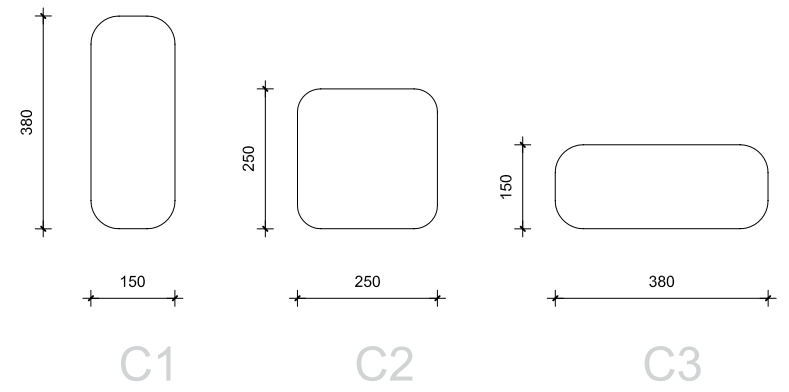
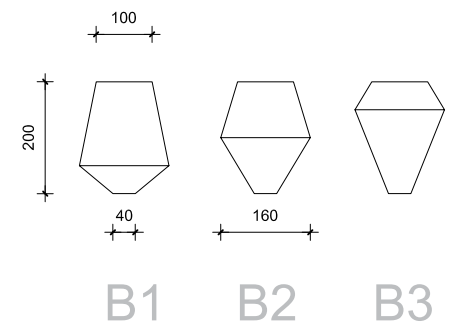
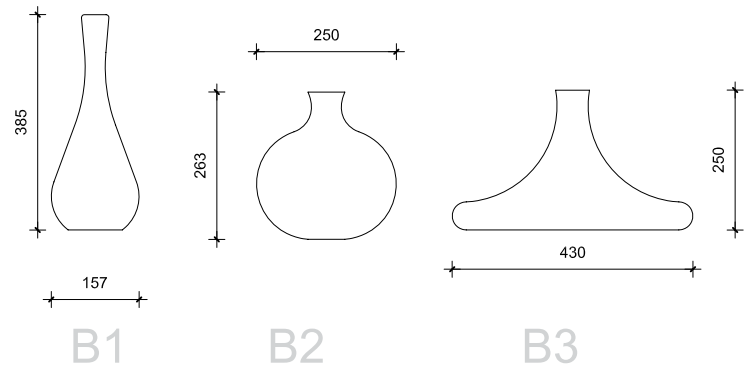
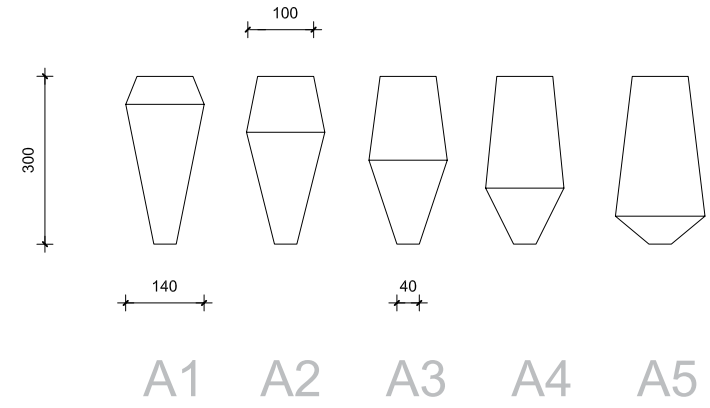

block

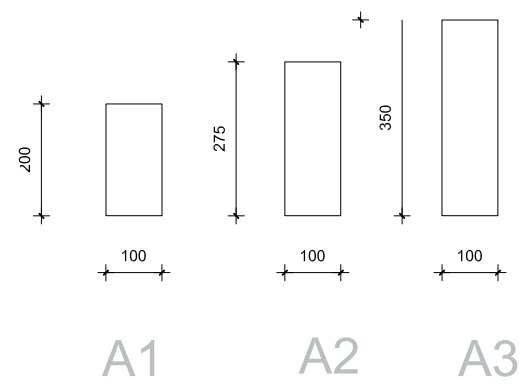

Cake Stand

Our Cake Stands are handmade on a lathe out of solid timber stumps. The vessels can then be finished in various colours or just be left natural.

Materials

Jacaranda

Plywood

Colours (we like)



* We can customise the material, colour and size according to your specifications.

Get in touch and we can talk about it.



Shapes

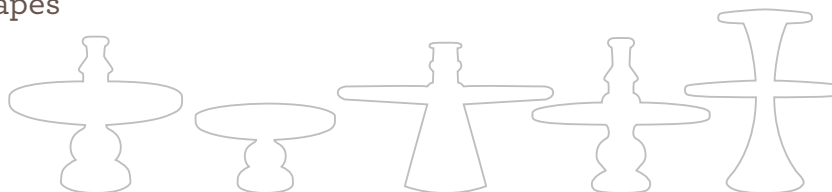

Candle Sticks ● ● ●

Our Candle Sticks are handmade on a lathe out of solid timber stumps. The vessels can then be finished in various colours or just be left natural.

Materials



Jacaranda

Colours (we like)



* We can customise the material, colour and size according to your specifications.

Get in touch and we can talk about it.



Shapes

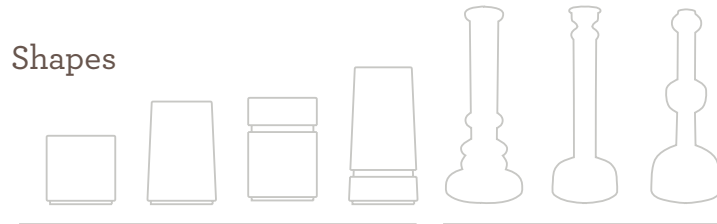

candle holder

deco stick



Candle Holder ● ● ●

Technical

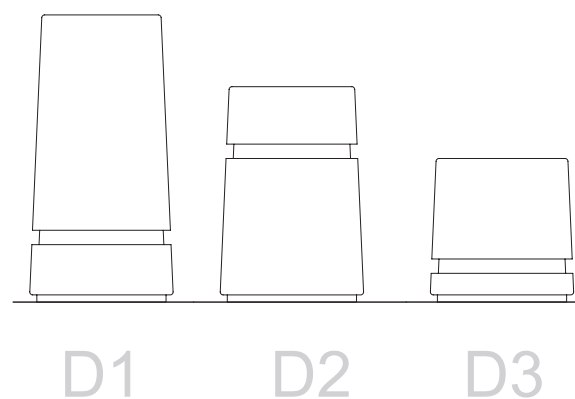
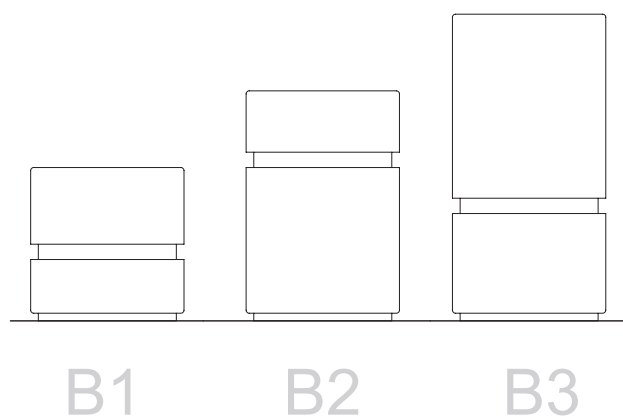
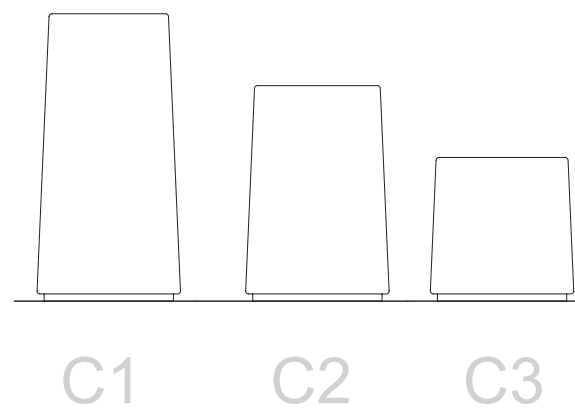
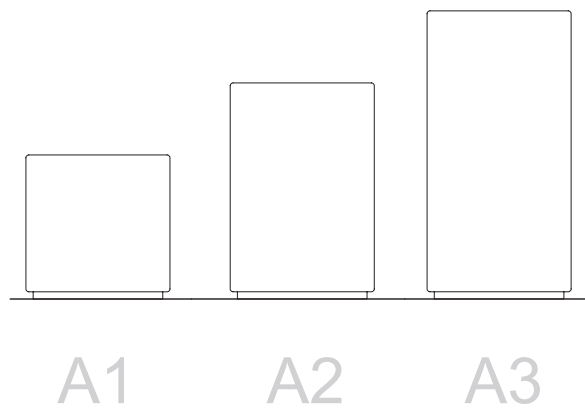

Urban Forest ● ● ●

The tree screen is build up using a mild steel base that can be manufactured in any colour or kept in a natural finish. The trees that are used are Eucalyptus and can be cut in various lengths. The trees can also be painted in any colour if so required.

Materials



Colours (we like)



Technical

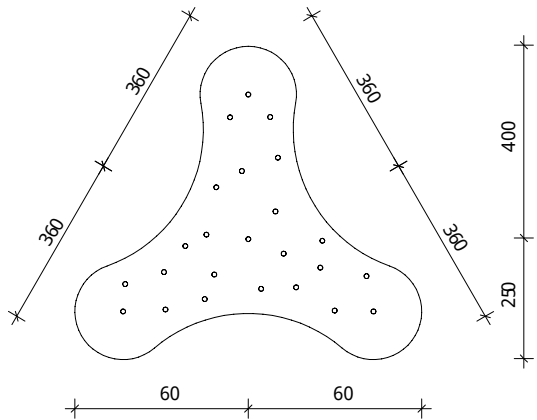

* We can customise the material, colour and size according to your specifications.

Get in touch and we can talk about it.

Jozi Table ● ● ●

The Jozi table reflects our love for the city we live in. Johannesburg of Jozi as fondly referred to is the inspiration for the table. The powder coated steel top is laser cut with a graphic representing the CBD of Johannesburg. This is done through a number of dots representing the street. Some areas, such as Nelson Mandela Bridge and Gandhi Square are highlighted in the graphic. The timber legs are mainly made from Ash, but any suitable timber from a sustainable source can be used. The legs are made up by using three basic legs and then a choice between three shapes for the fourth leg. These shapes represent three iconic buildings that are hand turned into the timber. The buildings represented are The Hillbrow tower, the Brixton Tower and the Ponte building.

Materials



Ash



Walnut



Steel

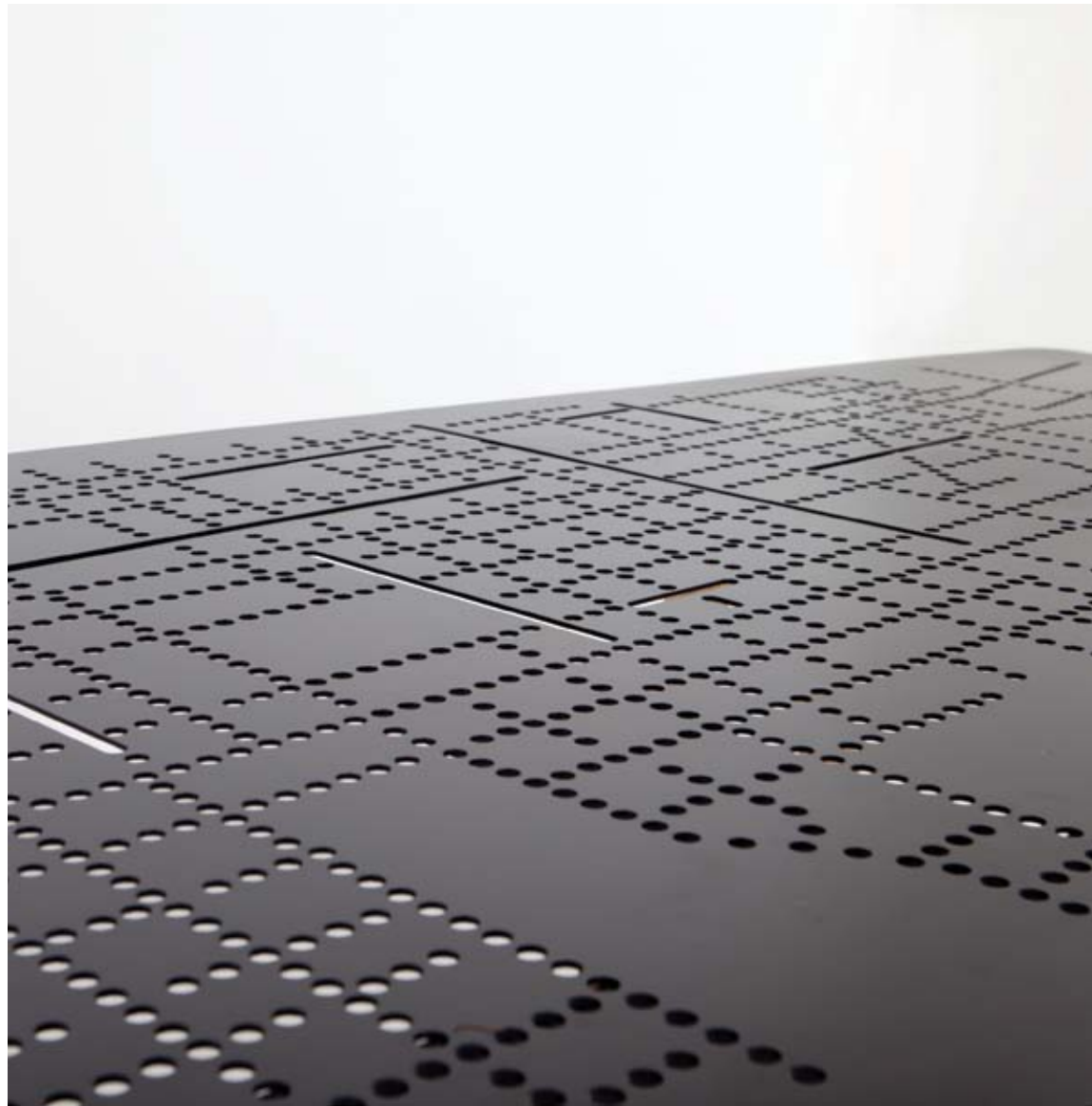

brixton



ponte



hillbrow



standard

* We can customise the material, colour and size according to your specifications.

Get in touch and we can talk about it.



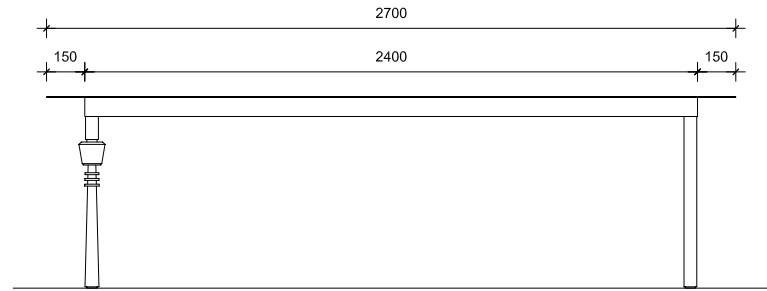
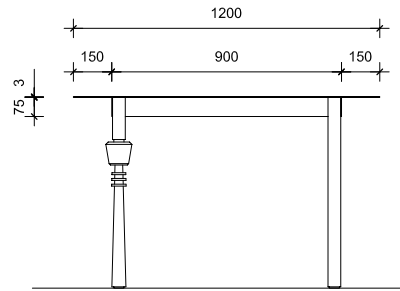
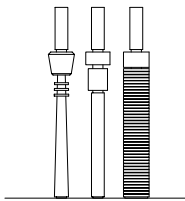
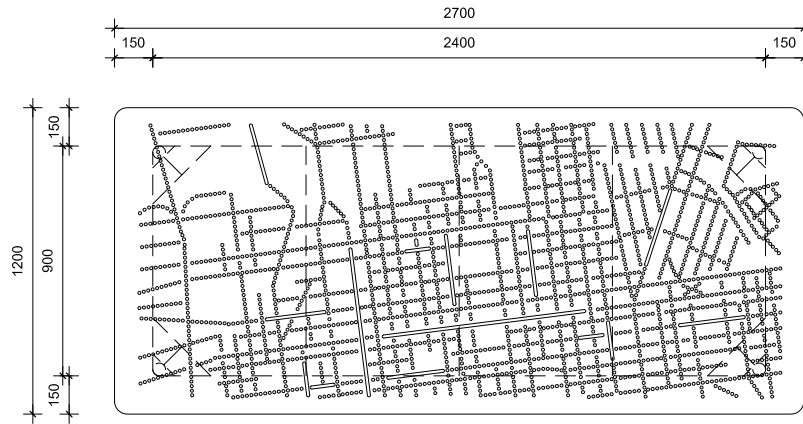

Lights ● ● ●

The shapes for the lights are derived from shape around us. For example some of the lights are derived from African pots and then extruded to form the various shapes. Our new range is more linear and interprets the future of South African contemporary forms and direction in design. The lights are manufactured from Jacaranda, but any timber from a sustainable source can be used. The lights can be manufactured to keep the natural quality of the timber or colour can be introduced in various ways.

Materials



Colours (we like)



Shapes



* We can customise the material, colour and size according to your specifications.

Get in touch and we can talk about it.

Lights ● ● ●

Technical

eco

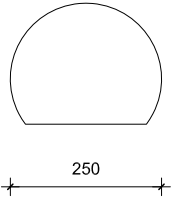

A1

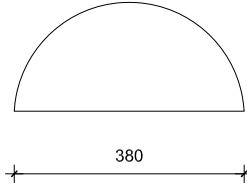
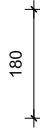

A2

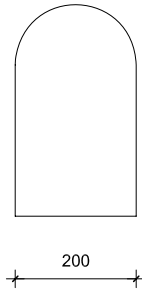
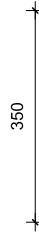

A3

evo

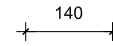

A1



A2

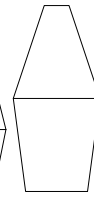

A3



A4



A5

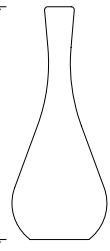
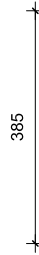

B1

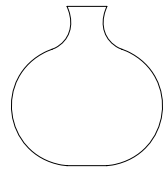
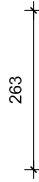
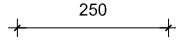

B2

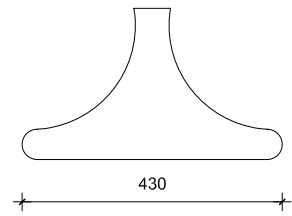

B3

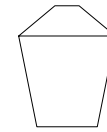

B1

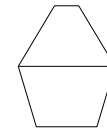
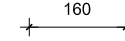

B2

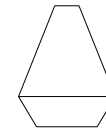

B3

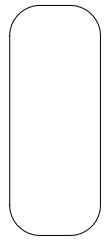
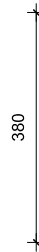

C1

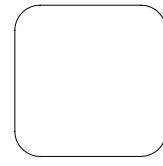
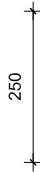

C2

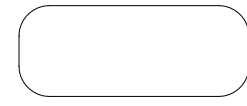
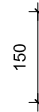

C3

block

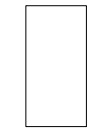
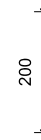

A1

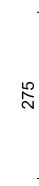

A2

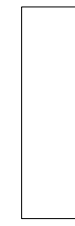
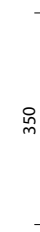

A3



Horse ● ● ●

The rocking horse is our take on the contemporary rocking horse. It is manufactured from steel and timber. The preferred timber used is Ash due to its durability in this application. The steel can be delivered in a number of colours and details.

Materials



Ash



Steel

Colours (we like)

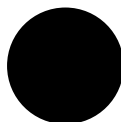
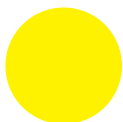

Technical

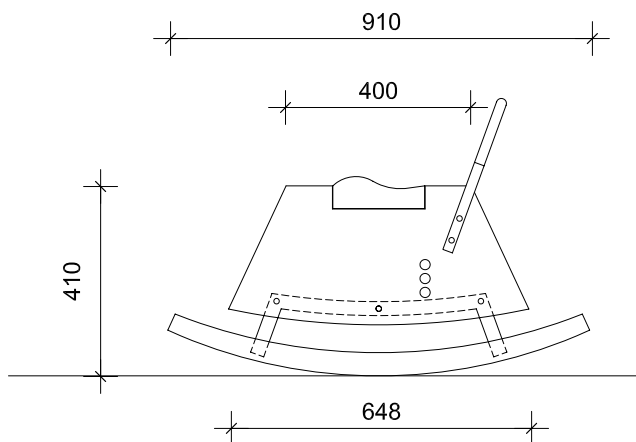

* We can customise the material, colour and size according to your specifications.

Get in touch and we can talk about it.



Couch ● ● ●

This couch epitomizes our design philosophy in that it is design around the use of natural material and combining it with steel. The different elements are kept in simple forms and then combined to form the couch. The timber used is ash but any timber from a sustainable source can be used. The steel elements are kept in a natural state, although they are sealed. The upholstery can be done in leather or fabric of choice. The couch can be ordered in various configurations. This can be done from a two seater to a four seater with or without a corner and a display extension. There is also an option for an ottoman add on.

Materials



Technical

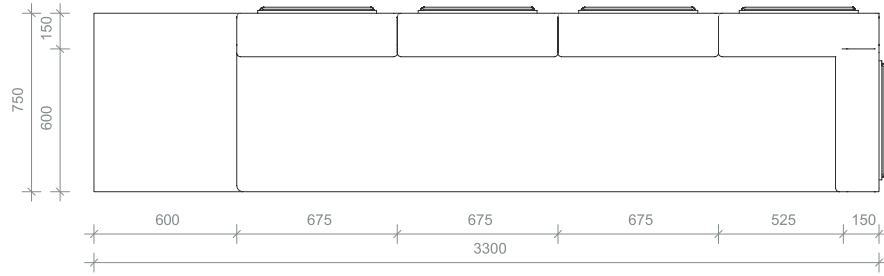

4 seater - right corner unit - extension

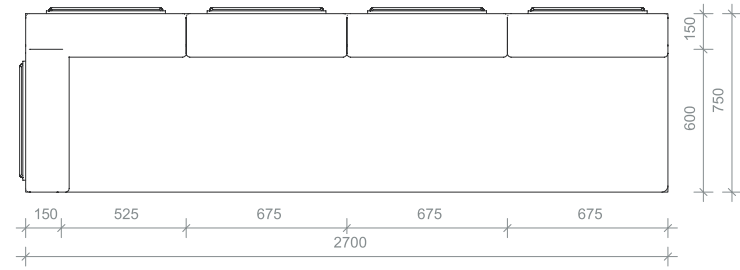

4 seater - left corner unit

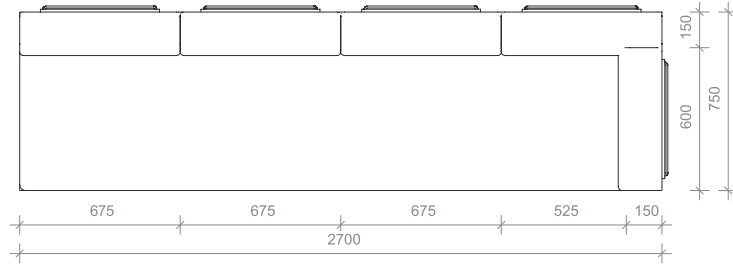

3 seater - right corner unit

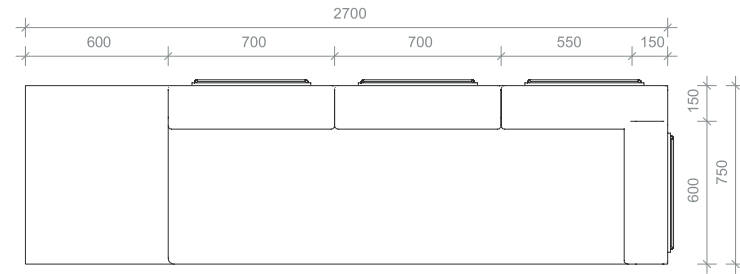

3 seater - right corner unit - extension

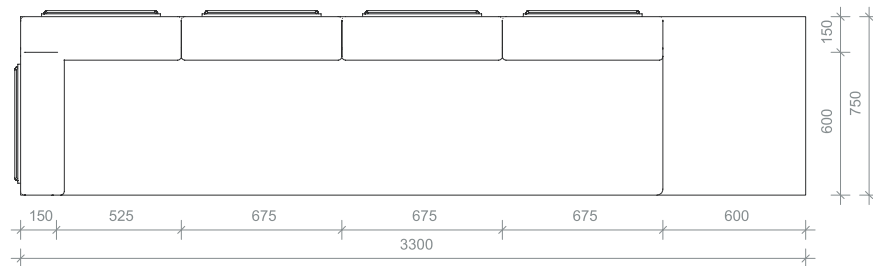

4 seater - left corner unit - extension

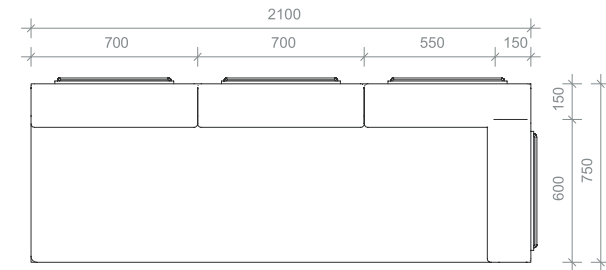

3 seater - right corner unit

Technical

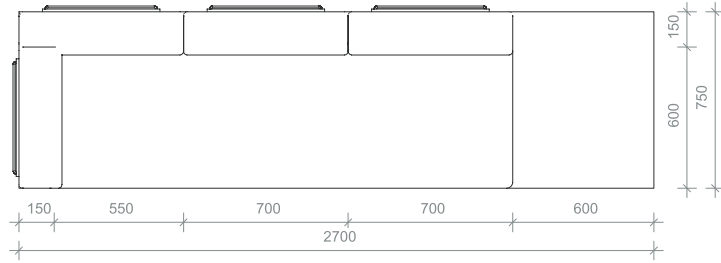

3 seater - left corner unit - extension

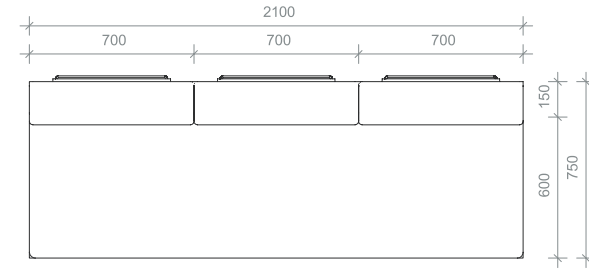

3 seater

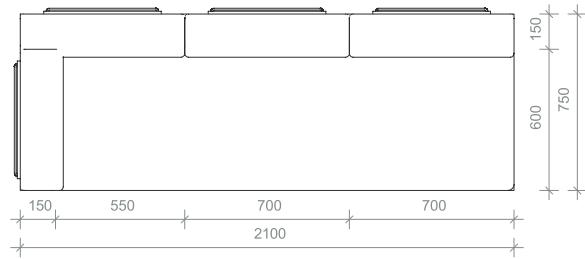

3 seater - left corner unit

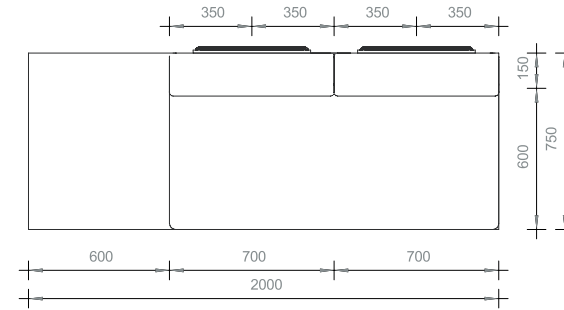

2 seater - extension

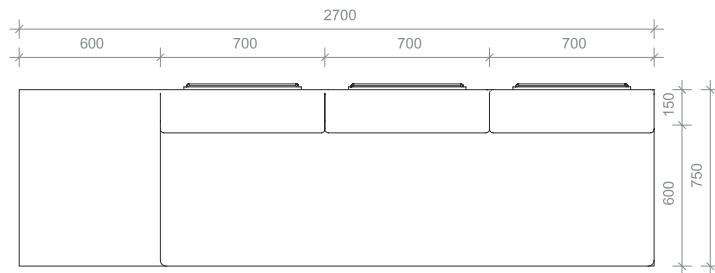

3 seater - extension

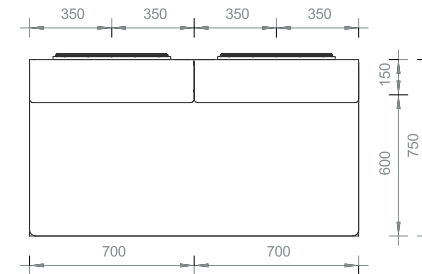

2 seater

Couch ● ● ●

Technical

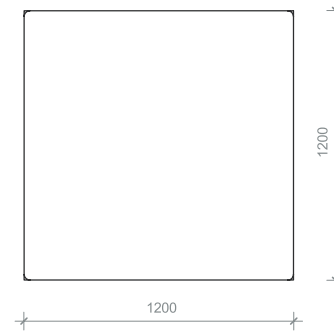

ottoman



daybed - extension



daybed



Southern Guild 2011 and Lights ● ● ●

This collection forms part of the Southern Guild 2011. Our contribution is lights, vessels and stools. The collection is made up off iconic shapes stripped to essence and these basic forms are finished with a jolt of colour.

Materials



Jacaranda



Eucalyptus

Colours (we like)

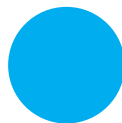
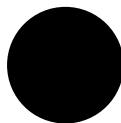
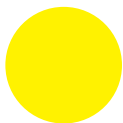

Shapes



* We can customise the material, colour and size according to your specifications.

Get in touch and we can talk about it.

Technical

vessels

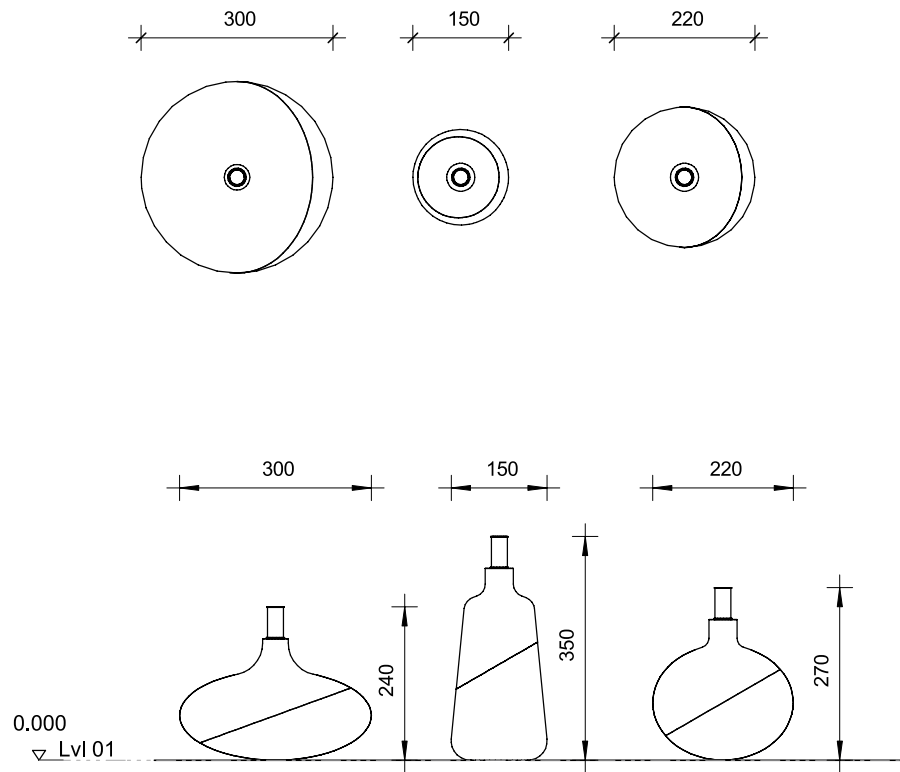

lights

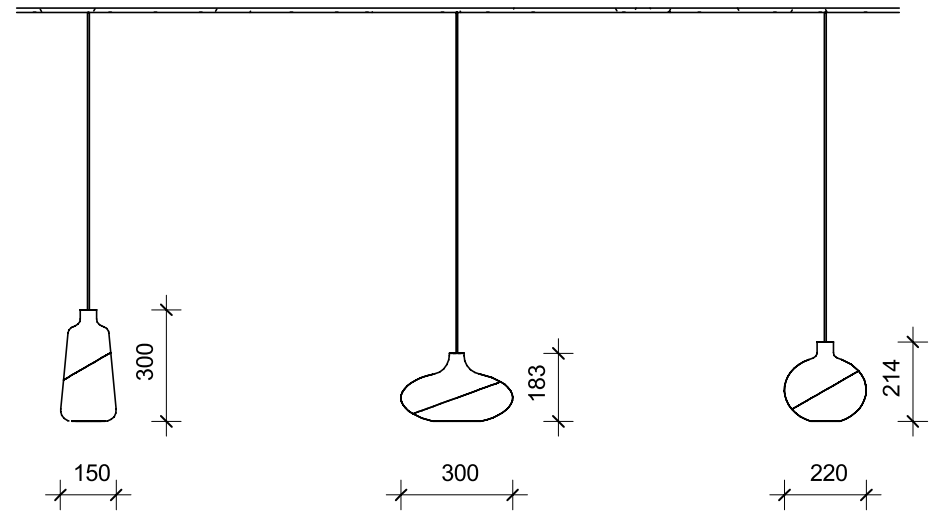

Recycling Bin/ Laundry ● ● ●

The Recycling and laundry bins are manufactured from perforated steel plate that is bent to a circular shape. The bins are then sprayed to a colour to suit and a timber lid is added. The lid is made from a mixture of timber with an icon laser etched into it to identify the bins use.

Materials



Ash



Steel

Powder Coated to clients' specification.

Technical

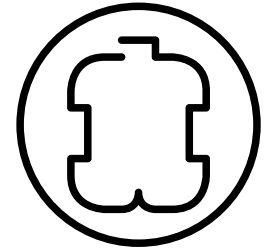
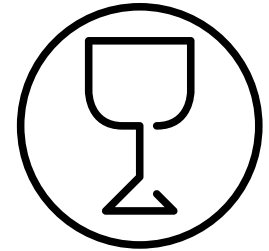
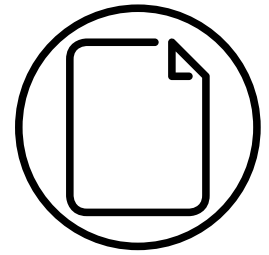
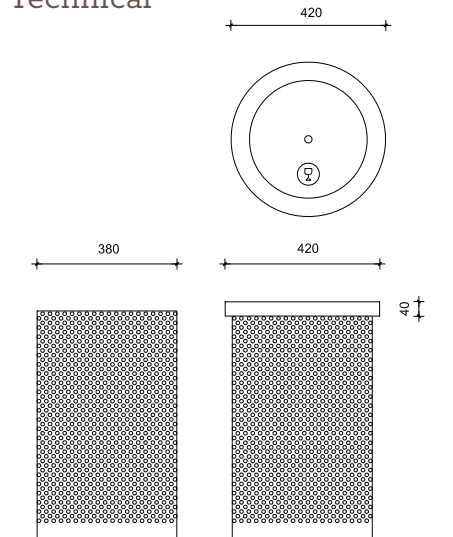

* We can customise the material, colour and size according to your specifications.

Get in touch and we can talk about it.



TV Unit #1 ● ● ●

This unit is manufactured from a solid ash base with a coloured appliance box on top. The base is manufactured from Ash but any timber from a sustainable source can be used. The appliance box is manufactured from MDF and is then sprayed using 2K to a desired colour. The box is closed using Perspex to hide the appliances although the infra-red signal can travel through the cover. The box is also design to accommodate the various wiring elements for the appliances in the box. The leg for the base is constructed from mild steel.

Materials



Ash



Perspex

Technical

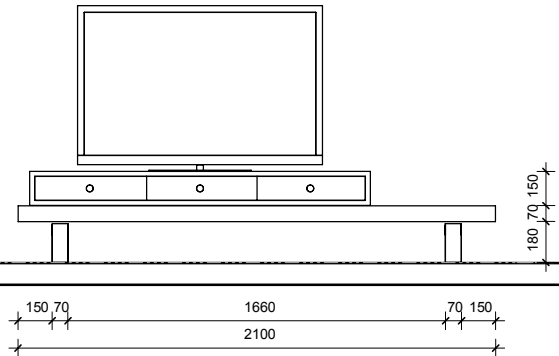
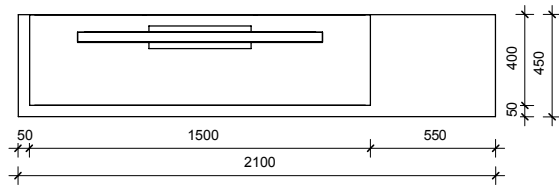

* We can customise the material, colour and size according to your specifications.

Get in touch and we can talk about it.



TV Unit #2 ● ● ●

This unit is manufactured from walnut veneer with a solid edge as an appliance box and then two MDF boxes, with 2K finish, as storage elements. These can be used to house DVD's, CD's and or books. The leg for the appliance box base is constructed from mild steel.

Materials



Ash



Perspex

Technical

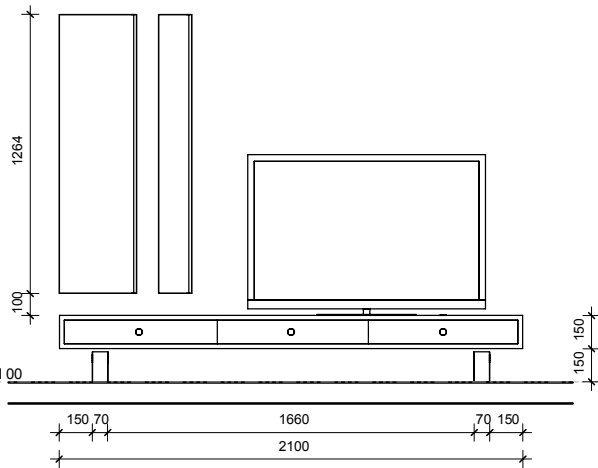
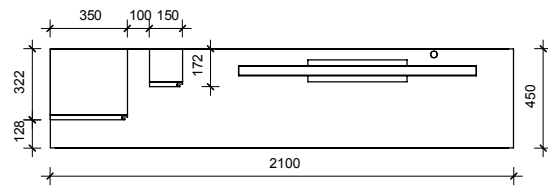

* We can customise the material, colour and size according to your specifications.

Get in touch and we can talk about it.

Server

The server is manufactured with a mixture of walnut veneer and MDF with a 2K finish. The layout consists out of shelved storage space and drawers. This layout can be customised to requirement.

Materials



Technical

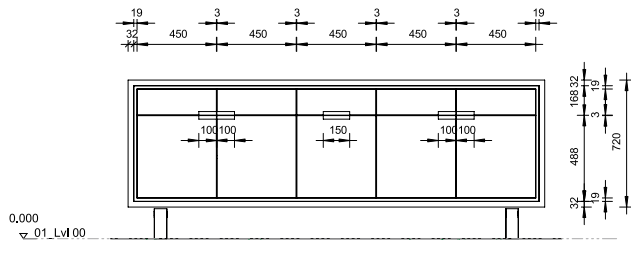

* We can customise the material, colour and size according to your specifications.

Get in touch and we can talk about it.

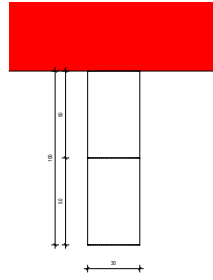

1 01
SCALE 1:1

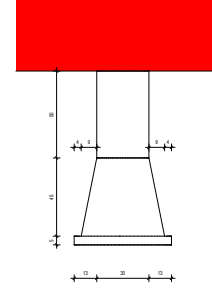

2 02
SCALE 1:1

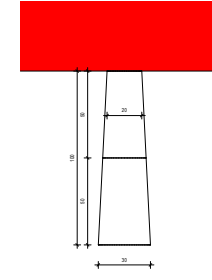

3 03
SCALE 1:1

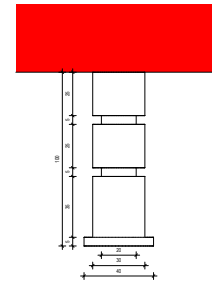
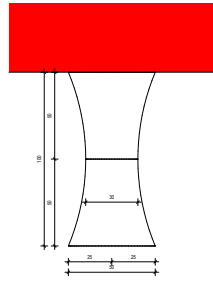

* We can customise the material, colour and size according to your specifications.

Get in touch and we can talk about it.